



Double Insulated Position Switches IN62, IN65 and I81

Double Insulated Position Switch IN62

- Position Switch in accordance with EN 50047
- Only available with plunger actuator



Advantages

- High reliability at low currents (1 mA)
- Protection class IP67
- Hinged snap-on cover
- Self cleaning contacts

Technical Data

- Mechanical service life:
up to 30 million switching cycles
- Contact safety: 1 mA for 24 VDC



Order data IN62 as complete system

The switches have standard fixings and an M20 cable entry.

IN62-... SK	Designation	Article number	System	Switching function
	IN62-SU1Z SK	6083000200	Snap action	1 NC / 1 NO
	IN62-U1Z SK	6083000201	Slow action	1 NC / 1 NO
	IN62-SA2Z SK	6083000202	Snap action	2 NC
	IN62-A2Z SK	6083000203	Slow action	2 NC
	IN62-SE2 SK	6083000204	Snap action	2 NO
	IN62-E2 SK	6083000205	Slow action	2 NO
	IN62-UV1Z SK	6083000206	Slow action	1 NC / 1 NO overlapping

Double Insulated Position Switch IN65

- Position Switch in accordance with EN 50047
- Modular design
- Easy modular adjustment of actuator head through 45° increments

Advantages

- High reliability at low currents (1 mA)
- Tool-free rotation and changing of actuator
- Actuator made of metal
- Protection class IP66 and IP67
- Hinged snap-on cover
- Self cleaning contacts

Technical Data

- Mechanical service life: up to 30 million switching cycles
- Contact safety: 1 mA for 24 V DC



Adjustable actuator elements

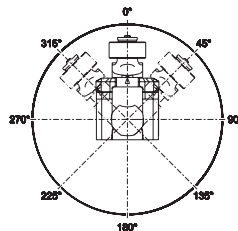

Rotatable lever

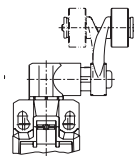

Adjustable lever

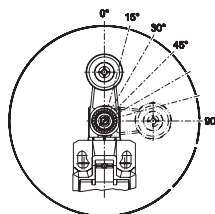

Rotate actuator

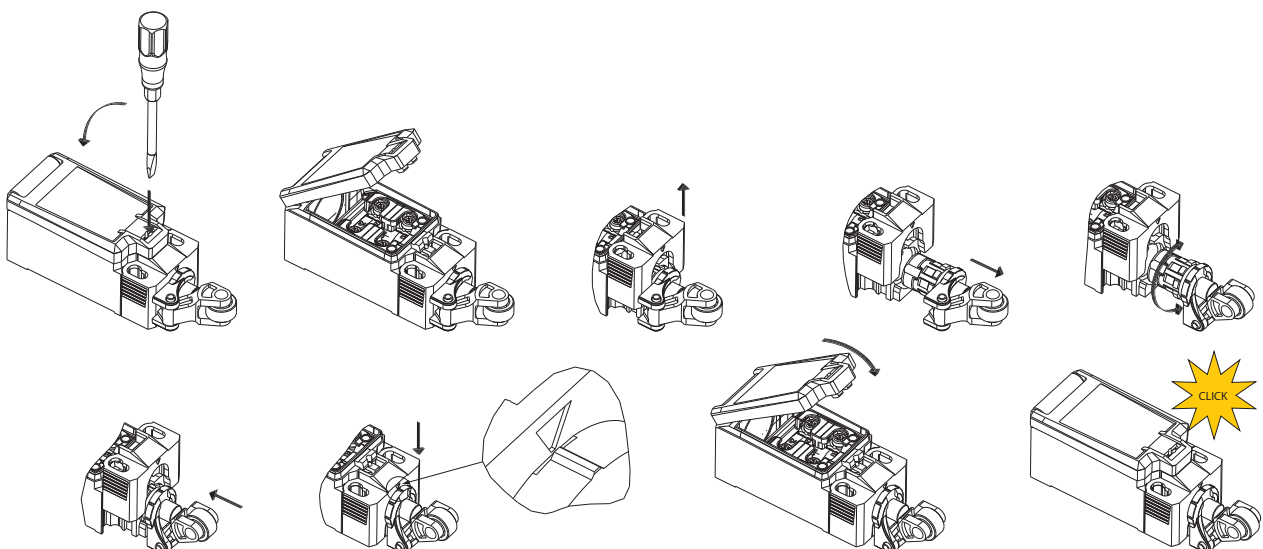

Double Insulated Position Switch I81

- Integrated latch function: After actuation manually reset by pulling the blue button necessary
- Modular design
- Easy modular adjustment of actuator head through 45° increments



Advantages

- High reliability at low currents (1 mA)
- Tool-free rotation and changing of actuator
- Actuator made of metal
- Protection class IP66 and IP67
- Hinged snap-on cover
- Self cleaning contacts

Technical Data

- Mechanical service life: 100.000 switching cycles
- Contact safety: 1 mA for 24 V DC



Adjustable actuator elements

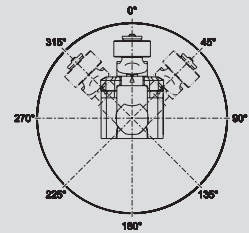

Rotatable lever

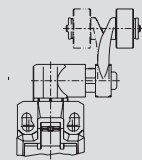

Adjustable lever

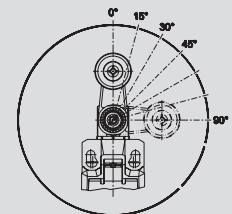

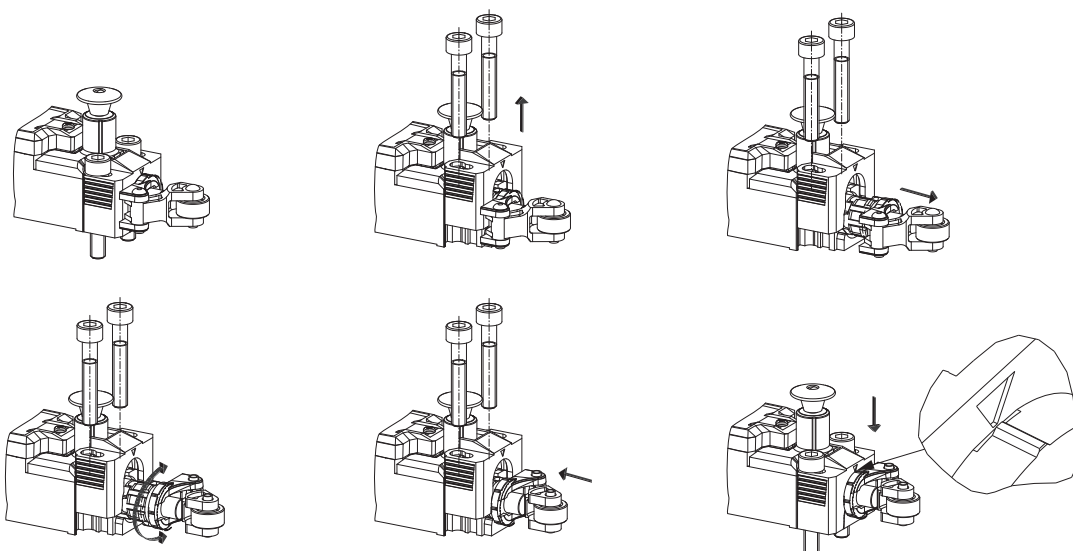

Rotate actuator



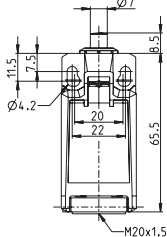

Order data IN65 as complete assembly

The switches have standard fixings and an M20 cable entry.

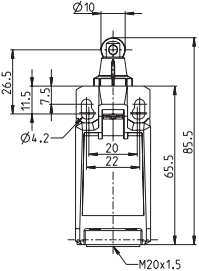
IN65-... SM	Designation	Article number	System	Switching function
 	IN65-SU1Z SM	6083000207	Snap action	1 NC / 1 NO
	IN65-U1Z SM	6083000208	Slow action	1 NC / 1 NO
	IN65-SA2Z SM	6083000209	Snap action	2 NC
	IN65-A2Z SM	6083000210	Slow action	2 NC
	IN65-SE2 SM	6083000211	Snap action	2 NO
	IN65-E2 SM	6083000212	Slow action	2 NO
	IN65-UV1Z SM	6083000213	Slow action	1 NC / 1 NO overlapping

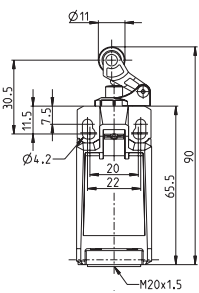
IN65-... RK	Designation	Article number	System	Switching function
 	IN65-SU1Z RK	6083000214	Snap action	1 NC / 1 NO
	IN65-U1Z RK	6083000215	Slow action	1 NC / 1 NO
	IN65-SA2Z RK	6083000216	Snap action	2 NC
	IN65-A2Z RK	6083000217	Slow action	2 NC
	IN65-SE2 RK	6083000218	Snap action	2 NO
	IN65-E2 RK	6083000219	Slow action	2 NO
	IN65-UV1Z RK	6083000220	Slow action	1 NC / 1 NO overlapping

IN65-... HK	Designation	Article number	System	Switching function
 	IN65-SU1Z HK	6083000221	Snap action	1 NC / 1 NO
	IN65-U1Z HK	6083000222	Slow action	1 NC / 1 NO
	IN65-SA2Z HK	6083000223	Snap action	2 NC
	IN65-A2Z HK	6083000224	Slow action	2 NC
	IN65-SE2 HK	6083000225	Snap action	2 NO
	IN65-E2 HK	6083000226	Slow action	2 NO
	IN65-UV1Z HK	6083000227	Slow action	1 NC / 1 NO overlapping

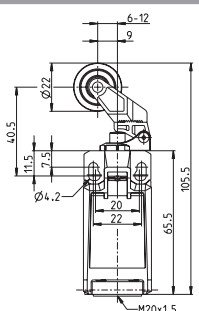
IN65-... DGHK	Designation	Article number	System	Switching function
 	IN65-SU1Z DGHK	6083000228	Snap action	1 NC / 1 NO
	IN65-U1Z DGHK	6083000229	Slow action	1 NC / 1 NO
	IN65-SA2Z DGHK	6083000230	Snap action	2 NC
	IN65-A2Z DGHK	6083000231	Slow action	2 NC
	IN65-SE2 DGHK	6083000232	Snap action	2 NO
	IN65-E2 DGHK	6083000233	Slow action	2 NO
	IN65-UV1Z DGHK	6083000234	Slow action	1 NC / 1 NO overlapping

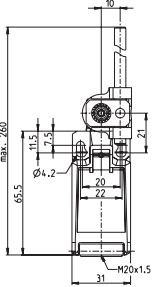
IN65-... AHDM	Designation	Article number	System	Switching function
 	IN65-SU1 AHDM	6083000307	Snap action	1 NC / 1 NO
	IN65-U1 AHDM	6083000303	Slow action	1 NC / 1 NO
	IN65-SA2 AHDM	6083000308	Snap action	2 NC
	IN65-A2 AHDM	6083000304	Slow action	2 NC
	IN65-SE2 AHDM	6083000309	Snap action	2 NO
	IN65-E2 AHDM	6083000305	Slow action	2 NO
	IN65-UV1 AHDM	6083000306	Slow action	1 NC / 1 NO overlapping

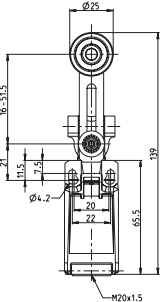
IN65-... AVK	Designation	Article number	System	Switching function
 	IN65-SU1 AVK	6083000280	Snap action	1 NC / 1 NO
	IN65-U1 AVK	6083000284	Slow action	1 NC / 1 NO
	IN65-SA2 AVK	6083000286	Snap action	2 NC
	IN65-A2 AVK	6083000279	Slow action	2 NC
	IN65-SE2 AVK	6083000288	Snap action	2 NO
	IN65-E2 AVK	6083000287	Slow action	2 NO
	IN65-UV1 AVK	6083000285	Slow action	1 NC / 1 NO overlapping

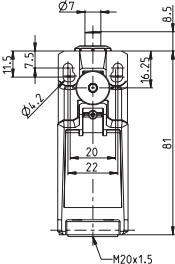
I81-...	Designation	Article number	System	Switching function
 	I81-U1Z SM	6083000242	Slow action	1 NC / 1 NO
	I81-U1Z RK	6083000243	Slow action	1 NC / 1 NO
	I81-U1Z HK	6083000244	Slow action	1 NC / 1 NO
	I81-U1Z DGHK	6083000245	Slow action	1 NC / 1 NO
	I81-U1Z DGKK	6083000268	Slow action	1 NC / 1 NO
	I81-U1Z KNK	6083000269	Slow action	1 NC / 1 NO
	I81-U1Z AHK	6083000246	Slow action	1 NC / 1 NO

Order data IN65/ I81 as component parts

Actuators

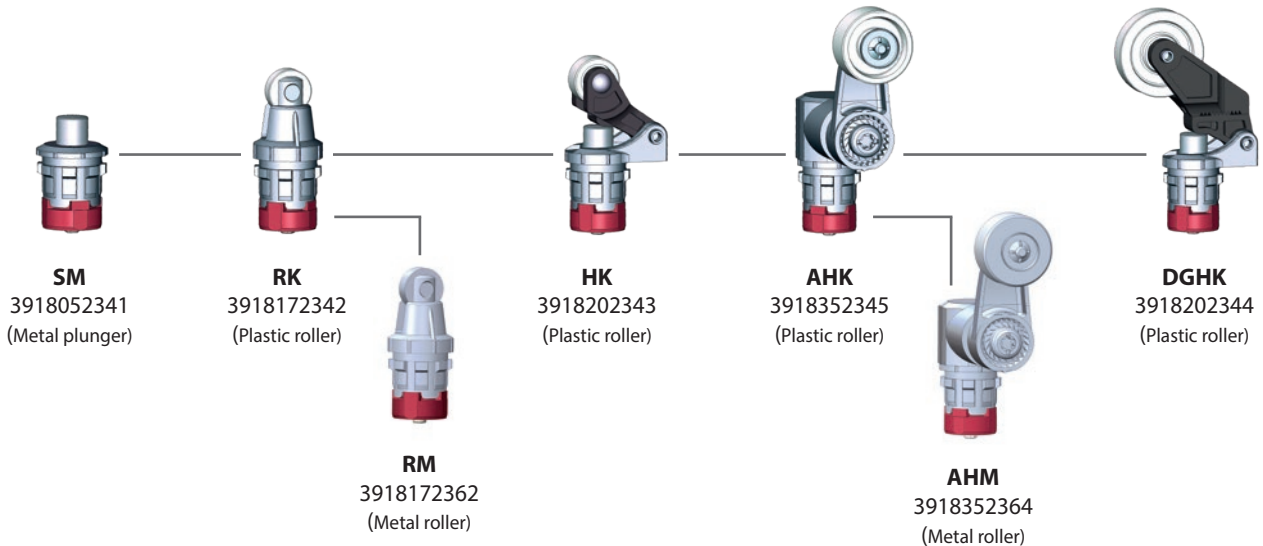

Designation	Article number	System	Switching function
C14-EB-U1Z	6005101156	Slow action	Changeover switch
C14-EB-SU1Z	6005151157	Snap action	Changeover switch
C14-EB-UV1Z	6005301158	Slow action	Changeover switch with overlapping
C14-EB-A2Z	6005801159	Slow action	2 NC
C14-EB-SA2Z	6005851160	Snap action	2 NC

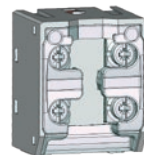

Switching unit

Housing without switching unit

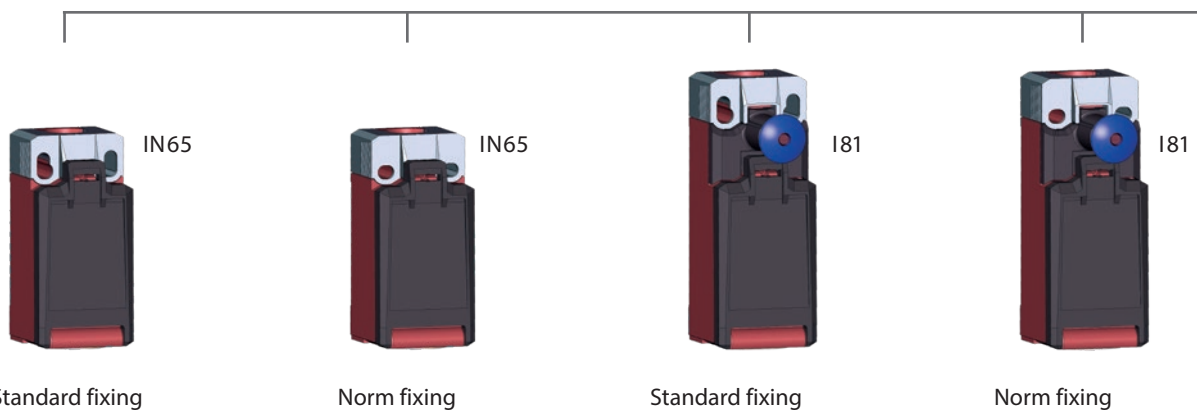

Cable outlet	Article no.	Cable outlet	Article no.	Cable outlet	Article no.	Cable outlet	Article no.
M16	6083000247	M16	6083000249	M16	6083000251	M16	6083000253
M20	6083000248	M20	6083000250	M20	6083000252	M20	6083000270

Housings also available in black.

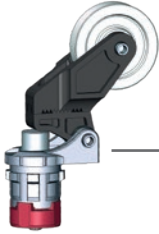

DGKK
3918202348
(Plastic roller)

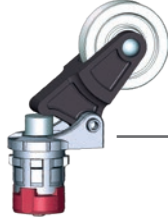

KNK
3918262349
(Plastic roller)

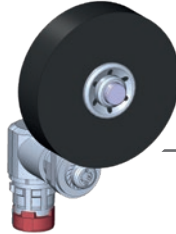

AHSGU RO50
3918352359
(Rubber roller)



AVZK
3918362358
(Plastic roller)

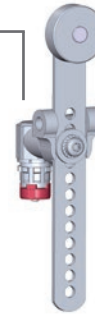

AVZM
3918362365
(Metal roller)

Housing with switching unit



**Housing with switching unit
and M12 plug connector**



Designation	Article number	System	Switching function
IN65-SU1Z M20	6083000271	Snap action	1 NC / 1 NO
IN65-U1Z M20	6083000272	Slow action	1 NC / 1 NO
IN65-SA2Z M20	6083000273	Snap action	2 NC
IN65-A2Z M20	6083000274	Slow action	2 NC
IN65-SE2 M20	6083000275	Snap action	2 NO
IN65-E2 M20	6083000276	Slow action	2 NO
IN65-UV1Z M20	6083000277	Slow action	1 NC / 1 NO overlapping

Designation	Article number	System	Switching function
IN65-SU1Z M12	6083000293	Snap action	1 NC / 1 NO
IN65-U1Z M12	6083000289	Slow action	1 NC / 1 NO
IN65-SA2Z M12	6083000294	Snap action	2 NC
IN65-A2Z M12	6083000290	Slow action	2 NC
IN65-SE2 M12	6083000295	Snap action	2 NO
IN65-E2 M12	6083000291	Slow action	2 NO
IN65-UV1Z M12	6083000292	Slow action	1 NC / 1 NO overlapping

Application examples

- Monitoring of safety gates, hatches or protective hoods
- Position monitoring of moving parts
- Object detection in conveying technology
- End position control of components
- Position monitoring on rolling doors
- Monitoring of sliding doors





Contact

International Headquarters

BERNSTEIN AG
Hans-Bernstein-Str. 1
32457 Porta Westfalica
Phone +49 571 793-0
Fax +49 571 793-555
info@de.bernstein.eu
www.bernstein.eu

Denmark

BERNSTEIN A/S
Phone +45 7020 0522
Fax +45 7020 0177
info@dk.bernstein.eu

France

BERNSTEIN S.A.R.L.
Phone +33 1 64 66 32 50
Fax +33 1 64 66 10 02
info@fr.bernstein.eu

Italy

BERNSTEIN S.r.l.
Phone +39 035 4549037
Fax +39 035 4549647
info@it.bernstein.eu

United Kingdom

BERNSTEIN Ltd
Phone +44 1922 744999
Fax +44 1922 457555
info@uk.bernstein.eu

Austria

BERNSTEIN GmbH
Phone +43 2256 62070-0
Fax +43 2256 62618
info@at.bernstein.eu

Switzerland

BERNSTEIN (Schweiz) AG
Phone +41 44 775 71-71
Fax +41 44 775 71-72
info@ch.bernstein.eu

Hungary

BERNSTEIN Kft.
Phone +36 1 4342295
Fax +36 1 4342299
info@hu.bernstein.eu

China

**BERNSTEIN Safe Solutions
(Taicang) Co., Ltd.**
Phone +86 512 81608180
Fax +86 512 81608181
info@bernstein-safesolutions.cn